

SHM Shaft Rings

Axially Assembled, External Tamper-Proof

The SHM also functions like an SH retaining ring, but in "smaller" applications. It is also a tamper proof ring which does not have any lugs and can not be easily removed once installed.

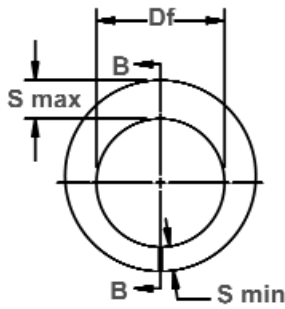

Free Diameter & Ring Measurements with Section B-B

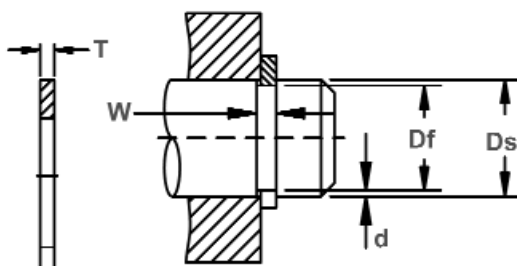

Shaft Diameter & Groove Dimensions

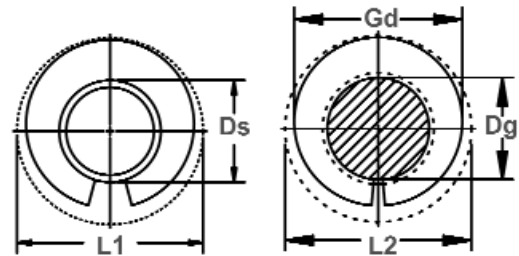

Clearance Diameter & Gaging Diameter

RING NO.	SHAFT DIAMETER inches			GROOVE SIZE					RING SIZE & WEIGHT				CLEARANCE DIA.			i THRUST LD. (lbs.) Sqr. Corner Abutment Groove w/90° wall	
				DIAMETER		WIDTH		DEPTH	FREE DIAMETER		THICKNESS***		Weight Per 1000 Pcs.	Expanded over shaft	Re-released in groove	Ring Safety Factor of 4	Groove Safety Factor of 2
	Ds DEC	Tol.	Ds FRACT	Dg	Tol.	W	Tol.	d	Df	Tol.	T	Tol.					
SHM-10	.101		-	.093	±.001	.024		.004	.090		.020		.036	.160	.152		30
SHM-12	.125	±.001	1/8	.115	.0015*	.024	+ .002	.005	.112		.020		.050	.186	.176		40
SHM-13	.134		-	.124		.024	- .000	.005	.120	±.002	.020		.059	.197	.187		45
SHM-15	.156		5/32	.144		.029		.006	.140		.025		.122	.252	.240	**	65
SHM-18	.188		3/16	.174		.029		.007	.168		.025		.179	.297	.283	SEE NOTE	90
SHM-20	.203		13/64	.189		.029		.007	.180		.025	±.002	.167	.302	.288	BELOW	100
SHM-22	.219		7/32	.205		.039		.007	.200	±.003	.035	±.002	.334	.345	.331	**	110
SHM-25	.250		1/4	.232	±.0015	.039		.009	.224		.035		.386	.384	.366		160
SHM-26	.266		17/64	.248	+ .002*	.039	+ .003	.009	.240		.035		.467	.406	.388		170
SHM-31	.312	±.0015	5/16	.292		.039	- .000	.010	.284		.035		.626	.478	.458		220
SHM-32	.328		21/64	.308		.039		.010	.300		.035		.688	.498	.480		230
SHM-37	.375		3/8	.351	±.002.002*	.046		.012	.340		.042		1.035	.567	.543		315

*F.I.M. (FULL INDICATOR MOVEMENT)-MAXIMUM ALLOWABLE DEVIATION OF CONCENTRICITY BETWEEN GROOVE AND SHAFT.

i BASED ON HOUSINGS/SHAFTS MADE OF COLD ROLLED STEEL. FOR AN EXPLANATION OF FORMULAS USED TO DERIVE THRUST LOAD AND OTHER PERFORMANCE DATA, CONTACT THE ROTOR CLIP ENGINEERING DEPT.

***FOR PLATED RINGS, ADD .002" TO THE LISTED MAXIMUM THICKNESS. MAXIMUM RING THICKNESS WILL BE A MINIMUM OF .0002" LESS THAN THE LISTED GROOVE WIDTH (W) MINIMUM.

**CALL FOR INFORMATION:1-800-557-6867 (+1 732-469-7333)

INSTALLATION OF ROTOR CLIP SHM RINGS

Rotor Clip SHM retaining rings can be installed by means of a tapered mandrel and a bushing. The mandrel can be eliminated in applications where the shaft can be easily tapered, as illustrated below.

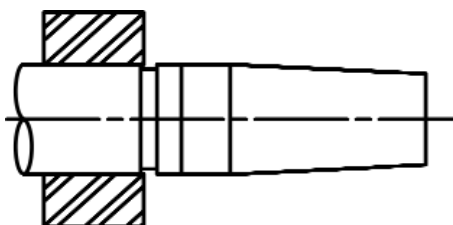

To install, place ring on mandrel and position bushing as shown. Ring can be pushed or tapped into groove.

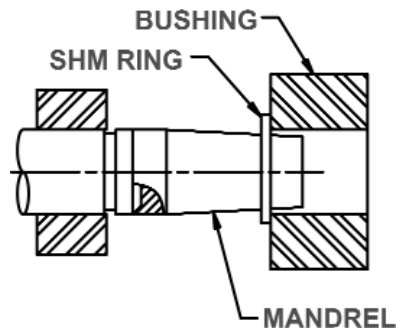

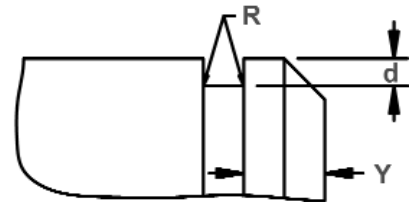
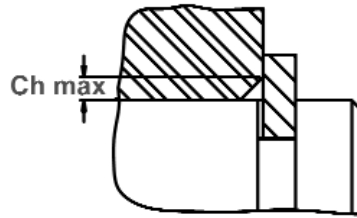
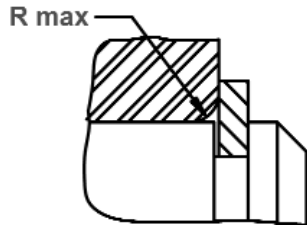

Maximum Corner Radius & Chamfer

Exploded Groove Profile & Edge Margin (Y)
Maximum bottom radii (R). Sharp corners-
no radii for ring sizes -10 thru -37.

RING NO.	S Max.	S Min.	GAGING DIA.	ALLOWABLE CORNER RADII &		MAX. LOAD w/ R max or Ch max. (in lbs.)	EDGE MARGIN	R.P.M. LIMITS Standard material	RING NO.	MANDREL					BUSHING		
	Ref.	Ref.		Gd Max	R max					Ch max	i P'r (lbs.)	Y	Dp	Tol.	W ref.	G	Tol.
SHM-10	.027	.017	.143	.013	.010	SEE NOTE ON PREVIOUS PAGE	.012	80000	SHM-10	.102		.036	.750		.104		3/8
SHM-12	.028	.018	.167	.013	.010		.015	80000	SHM-12	.126		.059	.750		.128		3/8
SHM-13	.029	.019	.178	.014	.011		.015	80000	SHM-13	.135		.069	.750		.137		3/8
SHM-15	.045	.027	.222	.021	.017		.018	80000	SHM-15	.157		.078	.875		.159		1/2
SHM-18	.052	.032	.264	.024	.019		.021	80000	SHM-18	.189		.110	.875		.191		1/2
SHM-20	.046	.030	.272	.023	.018		.021	80000	SHM-20	.204	+.000	.125	.875	±.005	.206	+.002	1/2
SHM-22	.058	.036	.308	.028	.022		.021	80000	SHM-22	.221	-.0015	.129	1.000		.223	-.000	1/2
SHM-25	.063	.037	.340	.028	.022		.027	80000	SHM-25	.252		.101	1.000		.254		5/8
SHM-26	.065	.037	.359	.027	.022		.027	80000	SHM-26	.268		.176	1.000		.270		5/8
SHM-31	.078	.050	.431	.038	.030		.030	80000	SHM-31	.314		.223	1.000		.316		5/8
SHM-32	.080	.050	.448	.038	.030		.030	80000	SHM-32	.330		.238	1.000		.332		5/8
SHM-37	.090	.058	.511	.042	.033		.036	80000	SHM-37	.377		.286	1.000		.379		5/8

LARGER SIZES MAY BE AVAILABLE UPON REQUEST.

HARDNESS RANGES: STAINLESS STEEL RINGS (PH 15-7MO)

RING TYPE	SIZE RANGE	SCALE	ROCKWELL HARDNESS
SHM	10-15	15N	82.5-86.0*
	18+	30N	63.0-69.5

*HARDNESS CAN NOT BE CHECKED WITH ANY DEGREE OF ACCURACY DIRECTLY ON THESE RINGS.

HARDNESS RANGES: BERYLLIUM COPPER RINGS

RING TYPE	SIZE RANGE	SCALE	ROCKWELL HARDNESS
SHM	10-15	15N	77.0-82.0*
	18+	30N	54-62

*HARDNESS CAN NOT BE CHECKED WITH ANY DEGREE OF ACCURACY DIRECTLY ON THESE RINGS.

HARDNESS RANGES: CARBON STEEL RINGS (SAE 1060-1090)

RING TYPE	SIZE RANGE	SCALE	ROCKWELL HARDNESS
SHM	10-15	15N	85.5-87.4*
	18+	30N	68.5-72

*HARDNESS CAN NOT BE CHECKED WITH ANY DEGREE OF ACCURACY DIRECTLY ON THESE RINGS.

PRODUCTION OF MANDREL AND BUSHING

Specifications for the production of a mandrel and bushing for installing SHM rings are listed in the above charts. Recommended material is high carbon spring steel, heat treated.

